



Installation Manual

Volkswagen Golf R Variant (Mk8)

# Before Installation

Welcome to iPE Exhaust.

Thank you for choosing iPE Exhaust. Please carefully read and follow the installation instructions below before proceeding with the installation. Improper installation may result in a voided warranty.

By reading this installation guide and installing the exhaust system, you have agreed to the terms and conditions stated in this manual. Please contact [support@ipeofficial.com](mailto:support@ipeofficial.com) for any further questions.

## Installation Instructions for iPE Exhaust System\*

- Please make sure the car is lifted properly. Failure to do so may cause vehicle damage and personal injury including death. Please make sure the car is lifted onto the proper lifting point.
- Exhaust systems can create extremely high temperatures. Prior to installing your iPE exhaust system, please allow your car engine to cool down or wear proper protective wear in order to prevent injuries during installation process.
- Please be careful, do not strip or break nuts and bolts during removal and installation. Please tighten the bolts to the correct specifications in order to prevent mechanical issues.
- With iPE Valvetronic exhaust systems, we recommend 3,000 rpm for valve actuation, in order to prevent excess resonance with exhaust sound.
- Please note, It is normal for white smoke to be visible on the first start. The smoke will dissipate after the exhaust reaches working temperature.
- For personal safety, please do not stand directly in front of the exhaust on first start. As it is a new exhaust system, the muffler is not yet active. There may be some manufacturing debris that will exit the exhaust system, which may cause injury.
- Please note, iPE exhaust system requires a break-in period, the exhaust sound and tone may change after driving approximately 300 miles (500 Km) after installation.

# Product Overlook

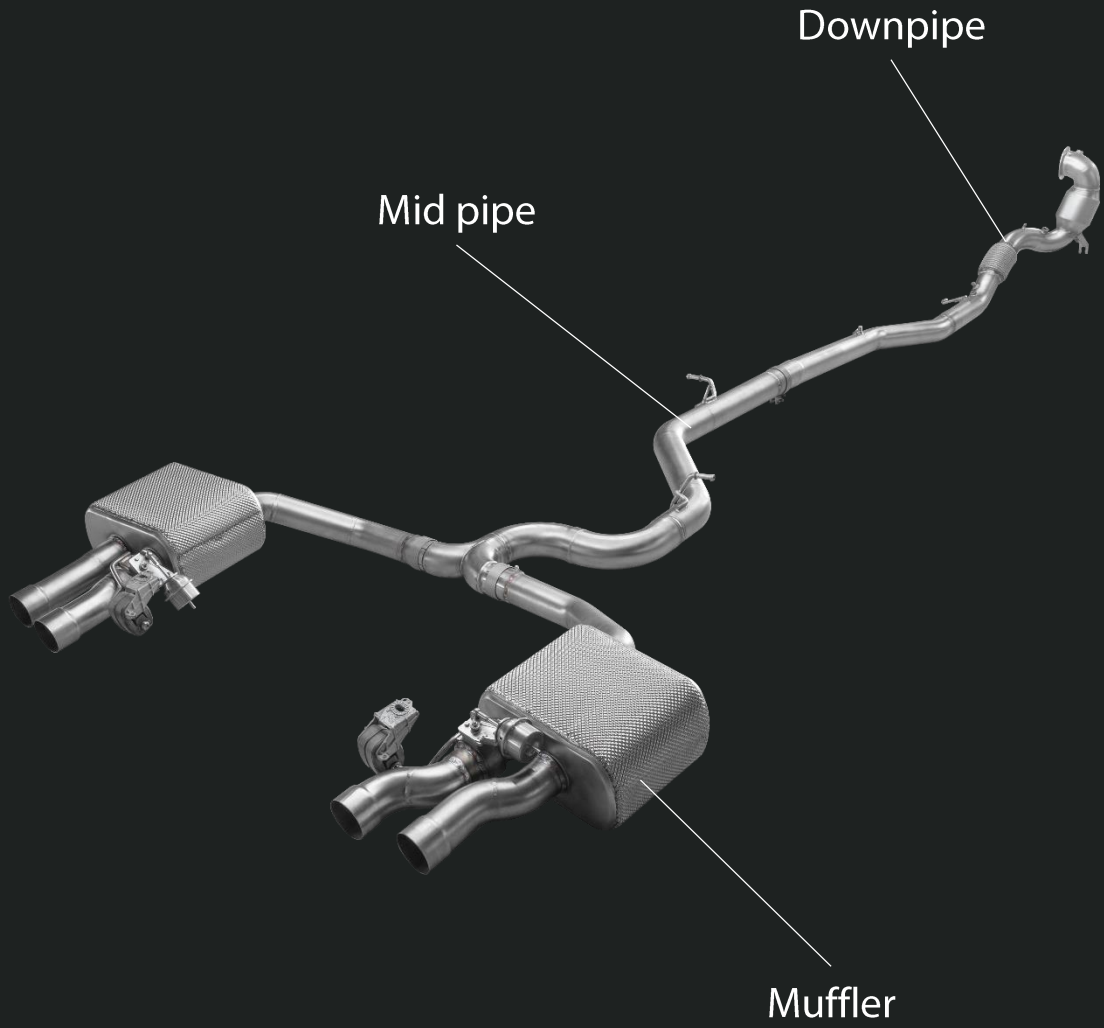

## Stock System Removal

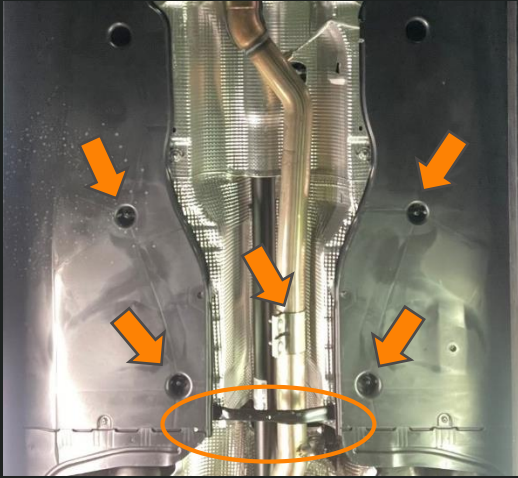

### Step 1

Remove the underbody panels on each side, then remove the underbody brace, in order to loosen and remove the rear section of the stock exhaust.

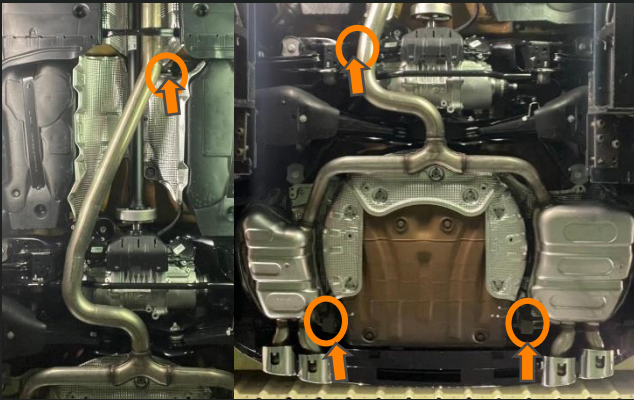

### Step 2

Remove the exhaust hangers at all 4 spots, in order to remove the stock catback system.

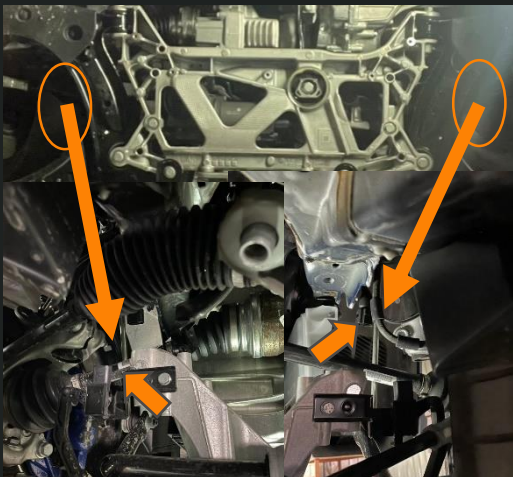

### Step 3

Unplug the speed sensors at the front, then remove the cover for the drive shaft.

## Stock System Removal

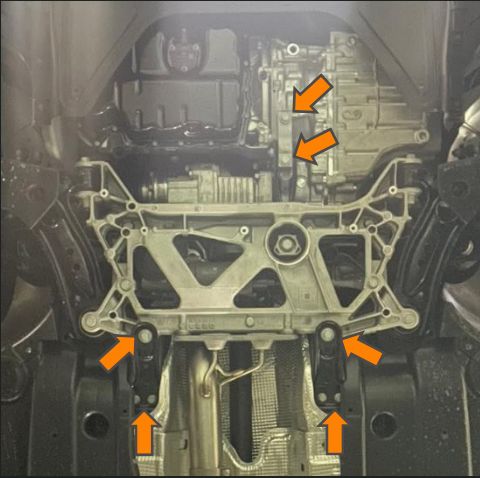

### Step 4

Place a jack beneath to support the subframe, then remove all 6 bolts on the structure that are connected to the subframe. Next, remove both bolts beneath the engine.

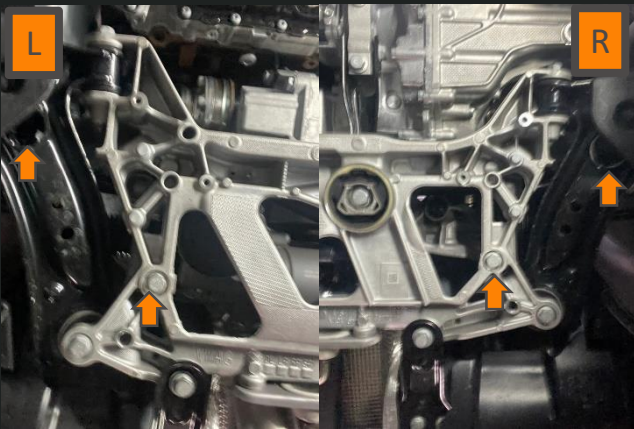

### Step 5

Remove the designated bolts on the wishbones and the subframe as shown in the image.

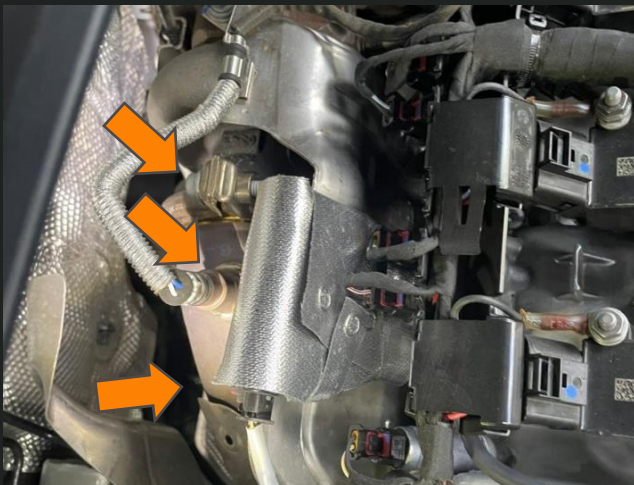

### Step 6

Remove the rear O2 sensor on the downpipe, then remove the clamp connected the downpipe to the turbo.

## Stock System Removal

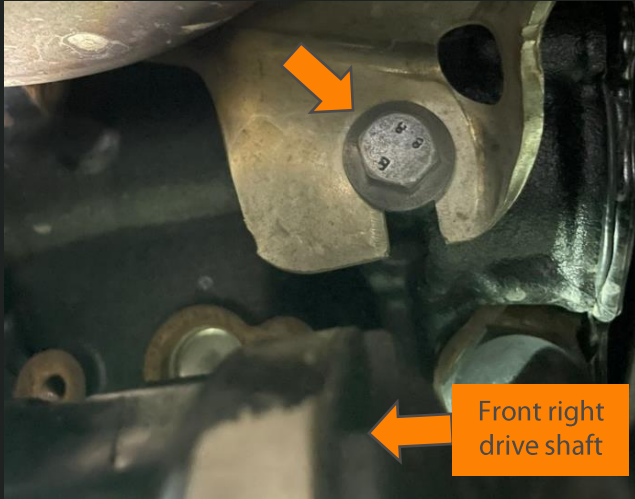

### Step 7

Remove the bolts on the downpipe hanger.



### Step 8

Unbolt both bolts in order to remove the downpipe hanger mount.

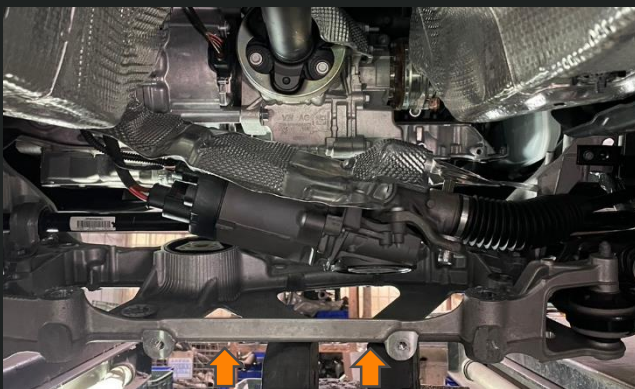

### Step 9

Slightly lower the jack until there's enough space to slide the stock downpipe out.

## Installation

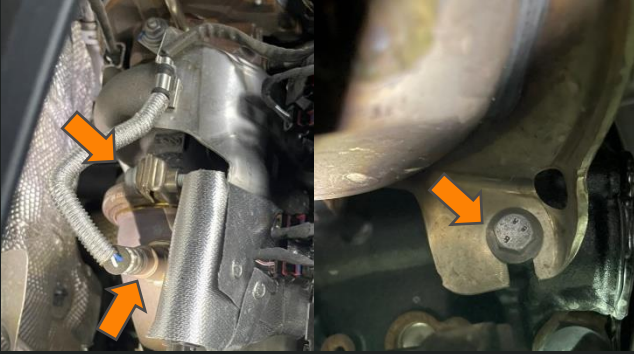

### Step 1

Install iPE downpipe, tighten the clamp connects to the turbo, then tighten the bolt for the downpipe hanger. Reinstall both front and rear O2 sensors once the downpipe is on.

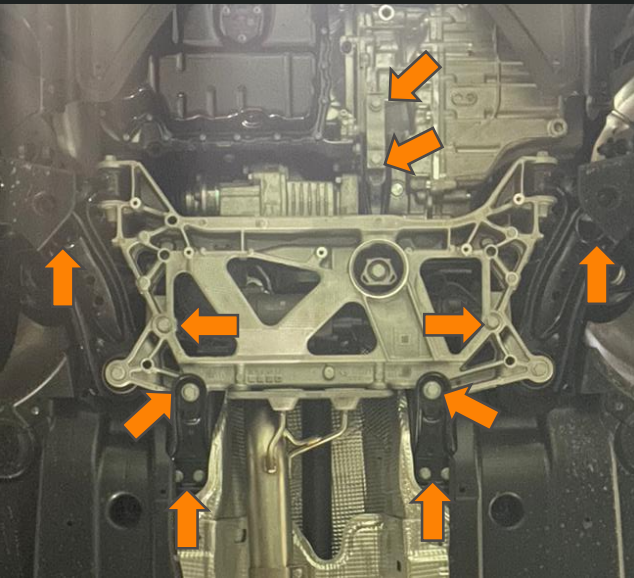

### Step 2

Tighten all 12 bolts for underbody structures back in place.

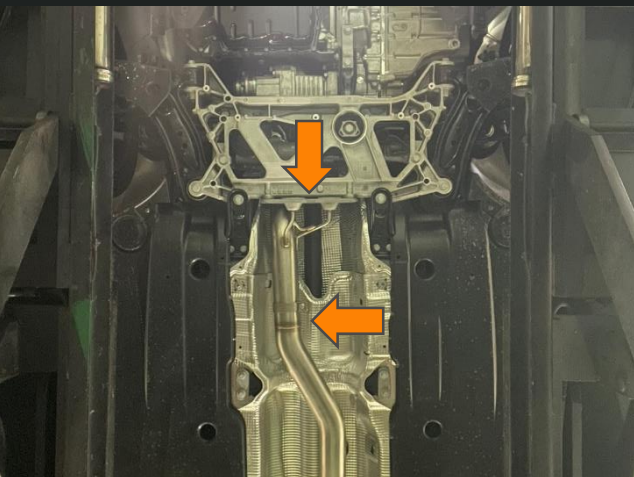

### Step 3

Tighten both bolts on the downpipe hanger mount, then install the rear section of the downpipe.

## Installation

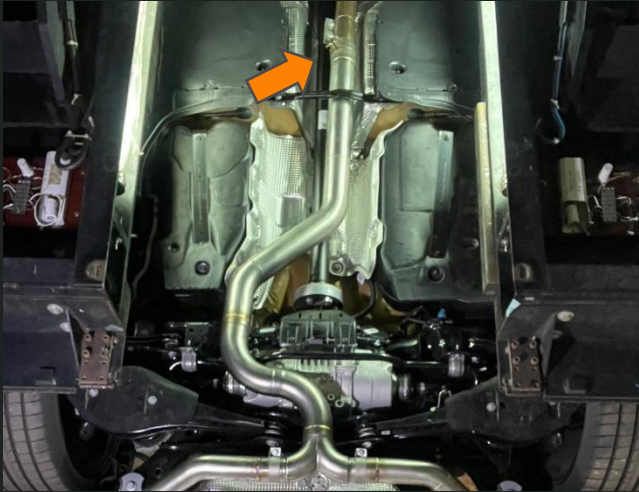

### Step 4

Install iPE Catback, tighten it just enough to hold it in place.

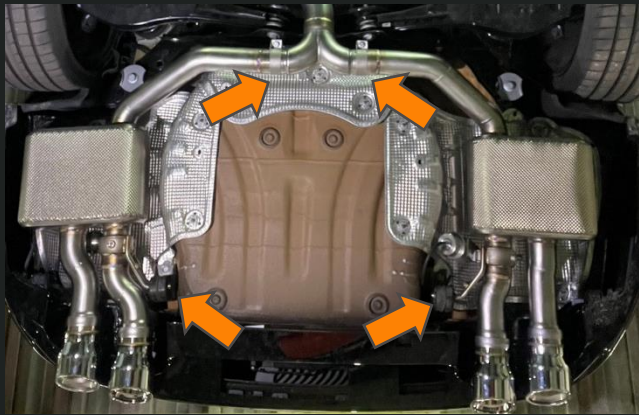

### Step 5

Install the muffler exit pipes and the tips on, adjust pipe position before tighten everything down.

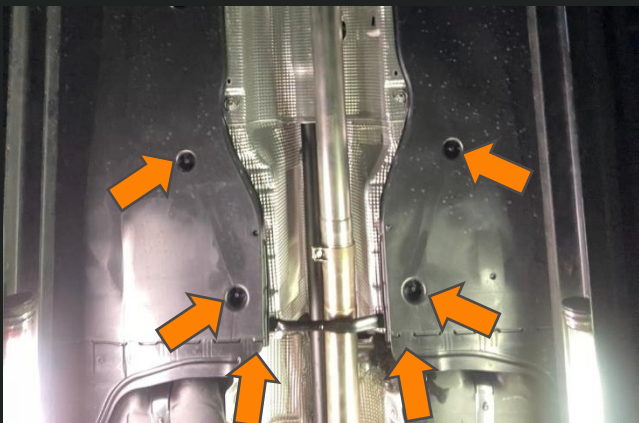

### Step 6

Install the underbody brace back in, then install the screws back onto the underbody covers to complete the installation.

\*Wheel alignment is recommended after the installation.



# iPE Remote Control System



- Remote Module ACC power Positive Red wire
- Remote Module ACC power Negative Brown wire
- Remote Module Throttle signal Yellow wire

# iPE OBDII Hand Gesture Control



--- ACC Power Positive

--- GND

--- Throttle Signal

## Installation



### Step 1

Plug the tube to the vacuum source.



### Step 2

Connect to the designated spot in the fuse box.



### Step 3

Connect to the throttle signal wire (white).  
Measure the voltage to confirm.

## Installation



### Step 4

Install the air tank to complete the installation.

## Return & Warranty

**1. Product Warranty Period:** iPE provides limited warranty services for one year starting from the shipping date. After verifying that the failure occurred within the warranty period by iPE. No inspection, parts, maintenance or other costs will be charged and of these costs will be incurred by iPE. Product warranties are non-transferable.

**2. Warranty Policy:** iPE's warranty services follows the standard operating procedure (SOP): Repair → Replace → Refund. The principles of this procedure are as follow:

**Repair:** During the warranty period and under normal usage, iPE is responsible for free repairs if the problem is due to product quality issues.

**Replacement:** During the warranty period and under normal usage, if the product quality issue arises and is unable to be solved by repairing, iPE is responsible for the free replacement.

**Refund:** If the replacement of a new product does not resolve the issue and it is the product's quality fault that causes the product to be unable to be repaired and used, please notify iPE within 7 days and iPE will give a full refund including shipping costs.

3. Product quality problems which are not included in the warranty includes:

**Consumables:** Under prolonged use, damaged flanges/screws/flange gaskets/springs/diaphragms/several strips/aluminum adapters... or slight rusting or discoloration of the product is common and natural.

The heat protector (heat wrap or heat shield) is a consumable and has a limited life span. Due to difference in personal usage or frequent disassembly, damage caused by wear and tear is common.

The tips and oxidized blue/purple colors are decorative parts. Before installation, please make sure that the appearance meets the requirements. Once installed and used, the return or exchange of the appearance will not be accepted. Please note that the decorative products will be affected by extreme environments. Therefore, there may be slight discoloration after prolonged use. In order to extend the lifespan of the tips, DO NOT wash with corrosive chemicals.

A friendly reminder, whether it is a 200 cell catalyst or a catalyst-delete pipe, iPE products are designed for motorsport and race track use only. By deleting the catalytic converters or modifying certain parts of the exhaust system, the chances of triggering the CEL 'Check Engine Light' and 'OPF/GPF (Otto Particulate Filter / Gasoline Particle Filter)' warning signal are high in certain car models. Please note, our warranty DOES NOT cover this or any software incompatibilities.



## Return & Warranty

We recommend remapping the vehicle's ECU to prevent potential faults from occurring. The OBD control system adopts the CAN communication mode. If the vehicle itself does not support this mode or there are other OBD interface devices and taps in the vehicle. The OBD control system cannot be controlled normally, in this case, it is not covered by the warranty.

In order to protect the integrity and functionality of the exhaust system. During Valve OFF Mode, the valves will automatically open when it reaches 4,000 RPM as a safety precaution.(Remind that the remote controller needs to install the accelerator signal line and set properly.) (For example, when the car is accelerated to approximately 3,000 RPM, as a safety precaution in automatic mode, the manual mode control process requires the user to open the valves in time for safety measures).

4. Product damage which results the violation of normal usage, accidents or natural disasters is not covered by the warranty. Under the situations mentioned above, iPE will not be responsible for the cost of maintenance/inspection, parts and potential transportation fees.

5. iPE's warranty commitment to the product is limited to the quality issue of the product itself. Warranty commitments shall be limited to the product itself and shall not exceed the selling price of the product; to the fullest extent permitted by law, iPE shall not be liable for other damages (including but not limited to vehicle collisions or accidents, personnel maintenance costs, transportation costs, vehicle owners or employees, environmental issues, safety issues, loss of profits, and other related personal losses.)

6. Transformation of the iPE product's ownership will cause the warranty to be voided automatically.

7. If personal modifications are made to the iPE exhaust system or application of non-iPE standard accessories such as fire, heat protectors or ceramic coating are used. iPE will not be responsible for the damages and the warranty will be voided automatically.

8. The purchase of iPE 's exhaust system does not include the labor costs for initial installation, removal, and subsequent installation/inspection process.

9. Due to various environment such as temperature, humidity or any natural causes. There may be some slight rusting and/or discoloration after prolonged use. This is normal wear and tear and will not be covered under the warranty.

10. iPE warranty does not cover any product modifications without the consent of iPE and the warranty will automatically become invalid; if the modifications is made with the consent of iPE, except for the warranty failure for the modified part. Other products are still under the warranty commitment by iPE.





*PERFORMANCE REDEFINED*

[www.ipeofficial.com](http://www.ipeofficial.com)

